



Electrolux
PROFESSIONAL

**Modular Cooking Range Line
thermaline 85 - 800 mm Open
base, GN conform, 1 Side (H2)**

ITEM # _____

MODEL # _____

NAME # _____

SIS # _____

AIA # _____



588579 (MB1BCAHO00) Open Base, one-side operated, GN - H2

Short Form Specification

Item No. _____

800 mm wide open base compartment to store pots, pans, sheet pans, etc. with hygienic design and round edges. Unit constructed according to DIN 18860_2 with 70 mm recessed plinth. Internal frame for heavy duty sturdiness in stainless steel. Flat surface construction, easily cleanable. Open storage space in the base accepts GN1/1 containers. IPX5 water resistant certification.

Configuration: One side operated freestanding base, hygienic class H2.

Main Features

- All major components may be easily accessed from the front.
- THERMODUL connection system creates a seamless work top when units are connected to each other thus avoiding soil penetrating vital components and facilitating the removal of units in case of replacement or service.
- IPX5 water resistance certification.
- Unit constructed according to DIN 18860_2 with 70 mm recessed plinth.

Construction

- Storage space in the base of the appliance that can accept GN1/1 containers.
- Hygienic design of the open base compartment with large round edges.
- 2 mm top in 1.4301 (AISI 304).
- Flat surface construction with minimal hidden areas to easily clean all surfaces
- Internal frame for heavy duty sturdiness in stainless steel.

Optional Accessories

- Stainless steel front kicking strip, 800mm width PNC 912634
- Stainless steel side kicking strip left and right, wall mounted, 850mm width PNC 912659
- Stainless steel side kicking strip left and right, back-to-back, 1700mm width PNC 912662
- Stainless steel side panel, 850x700mm, right side, against wall PNC 913003
- Stainless steel side panel, 850x700mm, left side, against wall PNC 913004
- Perforated shelf for warming cabinets and cupboard bases (one-side operated TL80-85-90 and two-side operated for TL80) PNC 913234
- Side reinforced panel only in combination with side shelf, for against the wall installations, right PNC 913261
- Side reinforced panel only in combination with side shelf, for against the wall installations, left PNC 913262
- Shelf fixation for TL80-85-90 one-side operated, TL80 two-side operated PNC 913281
- Stainless steel dividing panel, 850x700mm, (it should only be used between Electrolux Professional thermaline Modular 85 and thermaline C85) PNC 913670

APPROVAL: _____



Experience the Excellence
www.electroluxprofessional.com



Electrolux
PROFESSIONAL

Modular Cooking Range Line thermaline 85 - 800 mm Open base, GN conform, 1 Side (H2)

- Stainless steel side panel, 850x700mm, PNC 913686
flush-fitting (it should only be used
against the wall, against a niche and in
between Electrolux Professional
thermaline and ProThermetic
appliances and external appliances -
provided that these have at least the
same dimensions)

Modular Cooking Range Line
thermaline 85 - 800 mm Open base, GN conform, 1 Side (H2)

The company reserves the right to make modifications to the products
without prior notice. All information correct at time of printing.

2024.05.18



Electrolux
PROFESSIONAL

Modular Cooking Range Line thermaline 85 - 800 mm Open base, GN conform, 1 Side (H2)

Front

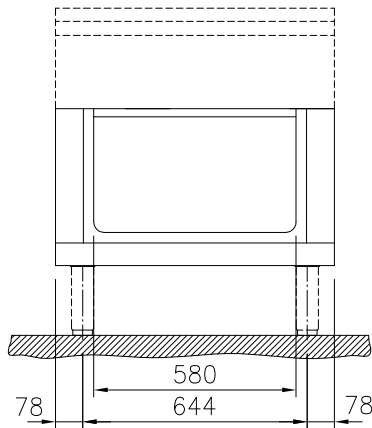

Side

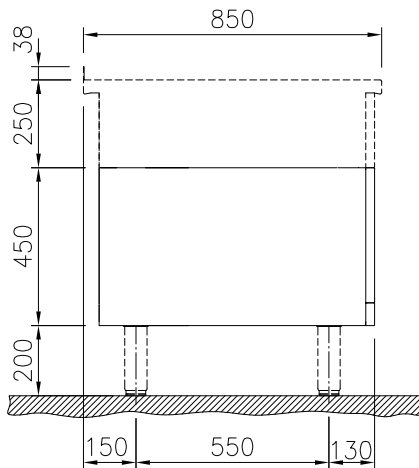

Top

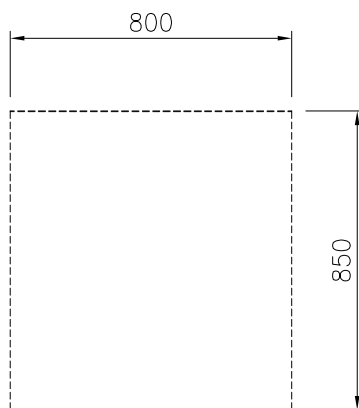

Key Information:

External dimensions, Width:	
588579 (MB1BCAH000)	800 mm
External dimensions, Depth:	850 mm
External dimensions, Height:	450 mm
Cupboard Cavity Dimensions (width):	580 mm
Cupboard Cavity Dimensions (height):	330 mm
Cupboard Cavity Dimensions (depth):	740 mm
Net weight:	21 kg



Modular Cooking Range Line
thermaline 85 - 800 mm Open base, GN conform, 1 Side (H2)

The company reserves the right to make modifications to the products without prior notice. All information correct at time of printing.

2024.05.18